

# EROSION AND SEDIMENT CONTROL GUIDELINES

MAY 2007  
CITY OF JOPLIN, MISSOURI  
PUBLIC WORKS DEPARTMENT

# CONTENTS

INTRODUCTION.....	3
GENERAL DESIGN GUIDELINES.....	3
Erosion Protection.....	4
Sediment Containment .....	4
Temporary Versus Permanent Controls.....	4
Maintenance .....	5
DESIGN STANDARDS AND CRITERIA .....	5
Erosion Protection.....	5
Grading.....	5
Cut and Fill Slopes .....	5
Channels and Swales.....	6
Seeding and Mulching.....	9
Sediment Containment .....	9
Existing Vegetation.....	11
Bale Dikes .....	12
Silt Fences.....	15
Temporary Sediment Basins .....	17
Storm Drain Inlet Protection.....	21
Bale and Filter Fabric Filters.....	22
Gravel And Wire Mesh Sediment Filters.....	24
Excavated Drop Inlet Sediment Trap.....	25
Gravel Curb Inlet Sediment Filter .....	27
Block and Gravel Curb Inlet Sediment Filter.....	28
SEDIMENT ON PUBLIC STREETS .....	29
Figure 1. Diversion Swale .....	6
Figure 2. Diversion Dike .....	6
Figure 3. Channel (Bottom < 15 ft wide).....	7
Figure 4. Channel (Bottom > 15 ft wide).....	7
Figure 5. Outlet Protection .....	8
Figure 6. Curb Opening Erosion Protection.....	9
Figure 7. Bale Dike Construction.....	12
Figure 8. Bale Dike Construction.....	13
Figure 9. Bale Dike Construction.....	14
Figure 10. Silt Fence Construction .....	17
Figure 11. Temporary Containment Berm .....	19
Figure 12. PVC Outlet Pipe .....	19
Figure 13. Stone Outlet .....	21
Figure 14. Bale Inlet Protection .....	23
Figure 15. Silt Fence Inlet Protection .....	24
Figure 16. Gravel and Wire Mesh Sediment Filter .....	25
Figure 17. Excavated Drop Inlet Sediment Trap .....	26
Figure 18. Gravel Curb Inlet Sediment Filter .....	27
Figure 19. Block and Gravel Curb Inlet Sediment Filter .....	28

## **INTRODUCTION**

These guidelines are intended to provide the designer, contractor and builder with design criteria and minimum standards for the installation of erosion and sediment controls to comply with the City of Joplin's Erosion and Sediment Control Regulations. The regulations were enacted to protect the health, safety, and property of the citizens of Joplin and to help protect area water resources from pollution due to erosion and transportation of sediment. The regulations are applicable to all land development and land disturbance activity within the City of Joplin where the area of disturbance is greater than 5,000 square feet. The regulations require that no person cause or allow sediment to be deposited in any public street, public land, or on any property not under their control as a result of land disturbance of more than 5,000 square feet resulting from construction activities.

You can comply with the regulations by meeting the following objectives:

- a. Minimize the area disturbed by construction and development;
- b. Provide for containment of sediment until areas are stabilized;
- c. Stabilize disturbed areas as soon as practical after project completion; and
- d. Provide permanent erosion, drainage, and detention controls.

## **GENERAL DESIGN GUIDELINES**

Erosion is a natural process where soil and rock are loosened and removed. Natural erosion normally occurs at a very slow pace, but when land is disturbed on a construction site, the erosion rate often increases dramatically. When erosion occurs on a construction site and runoff carries sediment off the site, there is often a negative impact on downstream drainage systems and water quality.

The purposes of erosion and sediment controls are to minimize the amount of erosion that occurs as a result of construction activity and to prevent the sediment that is produced from leaving the property. Effective erosion and sediment control requires that the soil surface be protected from the erosive forces of wind, rain, and runoff and that the eroded soil be captured and retained onsite. The following principles are effective when they are integrated into a system of control practices and management techniques to control erosion and prevent sedimentation offsite.

When designing sediment and erosion controls, it is necessary to determine whether there is sheet flow or concentrated flow of stormwater on the property. Sheet flow occurs on gently sloping land without defined drainage ways. The stormwater tends to disperse evenly across the property, although the drainage may be in one direction due to the overall slope of the property. Concentrated flow occurs on property where there are defined drainage ways that may range from gentle swales to clearly defined

waterways. It is possible to have a combination of sheet flow and concentrated flow on the same property.

## **Erosion Protection**

Proper planning will help identify potential erosion problems, particularly highly susceptible areas, such as areas of concentrated flow. Removing the vegetative cover and altering the soil structure by clearing, grading, and compacting the surface increases an area's susceptibility to erosion. Scheduling can be a very effective means of reducing erosion. Schedule construction activities to minimize the exposed area and the duration of exposure. Apply stabilizing measures as soon as possible after the land is disturbed. Plan and implement temporary or permanent vegetation, mulches, or other protective practices to correspond with construction activities. Protect channels from erosion forces by using protective linings and the appropriate channel design. Consider possible future repairs and maintenance of these practices in the design. In scheduling, take into account the season and the weather forecast.

Clearing existing vegetation reduces the surface roughness and infiltration rate and increases runoff velocities and volumes. This is particularly a concern in areas of concentrated flow. Use measures that break the slopes to reduce the problems associated with concentrated flow volumes and runoff velocities. Practical ways to reduce velocities include conveying stormwater runoff away from steep slopes to stabilized outlets, preserving natural vegetation where possible, and mulching and vegetating exposed areas immediately after construction.

## **Sediment Containment**

Even with careful planning some erosion is unavoidable, and the resulting sediment must be trapped on the site. In areas where runoff occurs primarily as sheet flow, containment of sediment is relatively simple. In these areas, temporary containment devices may be sufficient. Where concentrations of flow occur, containment of sediment becomes more difficult as the rate and volume of flow increase. In these areas, more extensive or permanent control devices need to be provided. Areas of steep topography and cut or fill slopes need to be given special consideration. Due to the environmental sensitivity of streams, rivers, losing streams, sinkholes, and mining features, special consideration also needs to be given to these areas. Plan the location where sediment deposition will occur and maintain access for periodic removal of accumulated sediment. Protect low points below disturbed areas by building barriers to reduce sediment loss. Sediment traps and basins should be constructed before other land-disturbing activities.

## **Temporary Versus Permanent Controls**

Temporary controls, such as straw or hay bale dikes, silt fences, erosion control blankets, etc., are provided for the purpose of controlling erosion and containing sediment until construction is complete. Temporary controls are not needed after the area is stabilized.

Permanent controls consist of riprap, concrete trickle channels, detention basins, etc., which will remain in place through the life of the development. It is possible for the same facility to serve both a temporary and permanent purpose.

## **Maintenance**

Inspection and maintenance are vital to the performance of erosion and sedimentation control measures. If not properly maintained, some practices may cause more damage than they prevent. Always evaluate the consequences of a measure failing when considering which control measure to use, since failure of a practice may be hazardous or damaging to both people and property. For example, a large sediment basin failure can have disastrous results, and low points in dikes can cause major gullies to form on a fill slope. It is essential to inspect all practices to determine that they are working properly and to ensure that problems are corrected as soon as they develop.

## **DESIGN STANDARDS AND CRITERIA**

Following are erosion and sediment control practices to consider for each project as needed. Other methods that achieve the ordinance requirements are encouraged. It is important to coordinate the temporary erosion control measures with the permanent control features to assure economical, effective, and continuous erosion control. Sufficient land area and/or easements must be available for the construction and maintenance of all erosion and sediment control devices to be used during construction.

### **Erosion Protection**

#### ***Grading***

Prior to grading, topsoil should be stripped from the site and stockpiled for reuse. To minimize the potential for future erosion, the maximum grades of cut or fill slopes should not exceed 33 percent (3:1). Cut or fill slopes should also not exceed 15 feet in vertical height unless a horizontal bench area at least five feet in width is provided for each 15 feet of vertical height. To provide for flow of stormwater over grassed areas the minimum slope should not be less than one percent (100:1).

#### ***Cut and Fill Slopes***

Cut and fill slopes need to be protected from erosion by constructing bale dikes, silt fences, diversion berms, or swales along the top of the slope. Where drainage must be carried down the slopes, pipe drains, concrete flumes, riprap chutes, or other nonerosive surfaces need to be provided. Suitable erosion control measures, such as riprap silting basins, should be provided at the bottom of the slope. Diversions should be maintained until permanent growth is firmly established on the slopes. Typical diversion details for swales and dikes are shown in Figures 1 and 2, respectively. For proper drainage, a minimum one percent (100:1) grade must be provided for the swale or along

the up-slope side of the dike. The dike must be compacted to a density equal to the adjoining area.

**Figure 1. Diversion Swale**

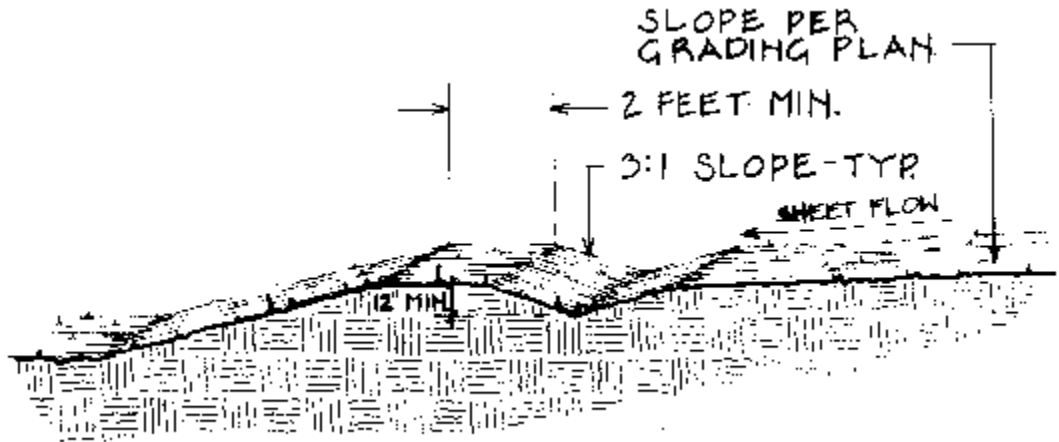

**Figure 2. Diversion Dike**

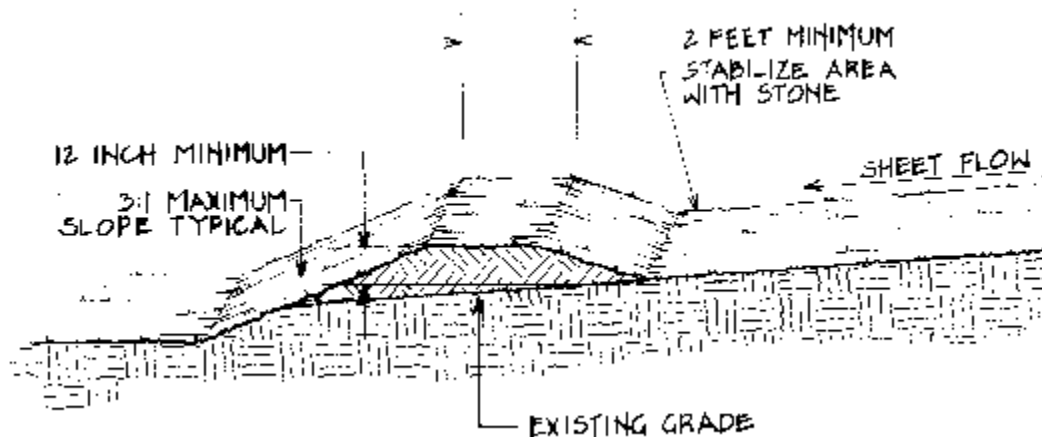

### ***Channels and Swales***

Permanent channels and swales should be provided with a stabilized invert (bottom of the channel or swale) consisting of sod, erosion control blankets or a non-erosive lining. A channel can be lined with sod where the average velocity of flow is five feet per second or less and there is no base flow. For channels with a bottom width less than 15 feet, sod should extend up the side slope to a minimum height of six inches above the toe (Figure 3). Channels with a bottom width of fifteen feet or greater should be graded

as shown in Figure 4, and a low flow area 15 feet in width should be lined with sod. Commercial erosion control blankets may be used in lieu of sod. The remainder of the channel slopes should be seeded and mulched as provided above.

**Figure 3. Channel (Bottom < 15 ft Wide)**

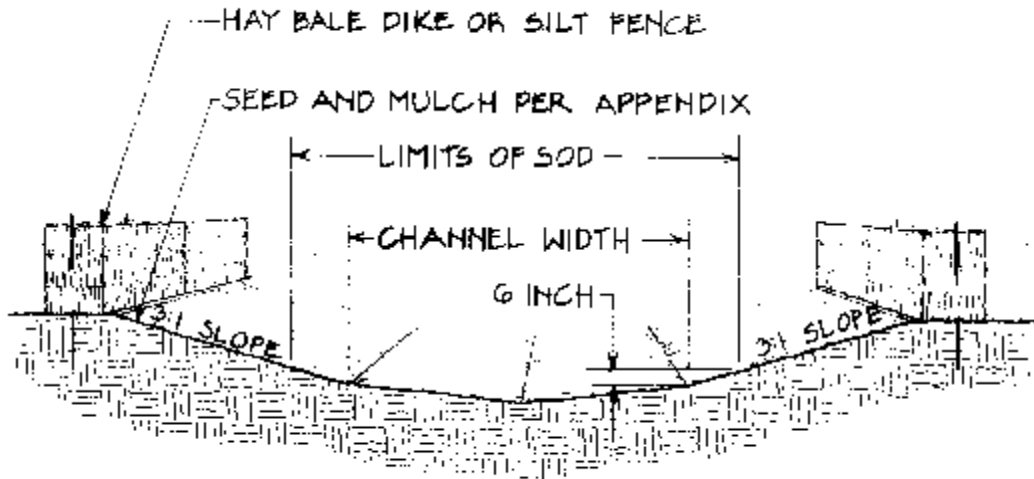

**Figure 4. Channel (Bottom > 15 ft Wide)**

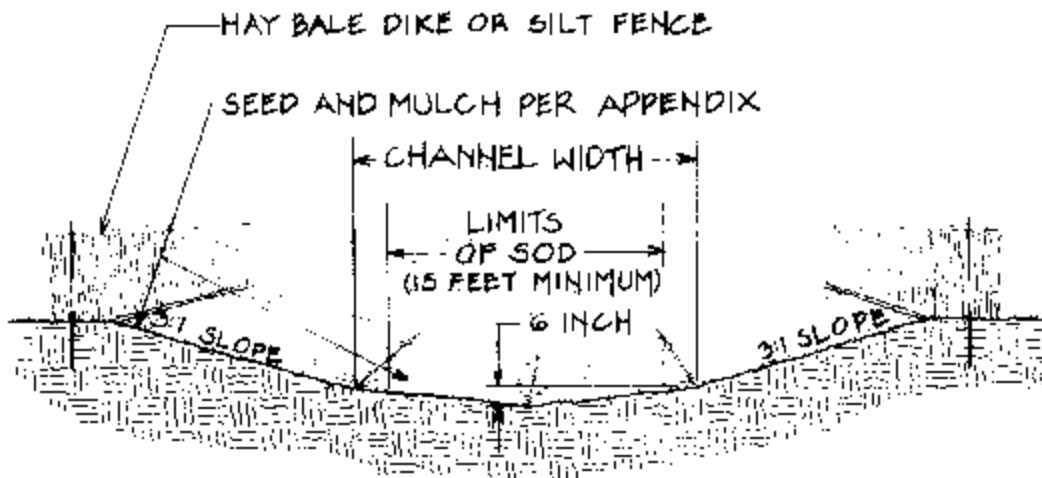

In grass channels where base flow occurs, a nonerosive low-flow channel of riprap or concrete should be provided. Low flow channels should have a minimum capacity of five cubic feet per second. For channels with an average velocity of five feet per second or greater, a non-erosive lining of riprap, concrete, or other approved material should be provided.

Erosion protection should be provided at storm sewer and culvert outlets. Minimum erosion protection should typically consist of a flared end section or a concrete headwall and a non-erosive lining. Non-erosive lining should consist of riprap or a suitable substitute. Field stone, gabions, or riprap should extend to the point at which average channel velocity for the peak flow rate from the minor (2 year) storm has decreased to five feet per second maximum. The length of protective lining to be provided should be as shown in Figure 5 for average outlet velocities up to ten feet. For average outlet velocities greater than ten feet per second, the Missouri Department of Transportation

**Figure 5. Outlet Protection**

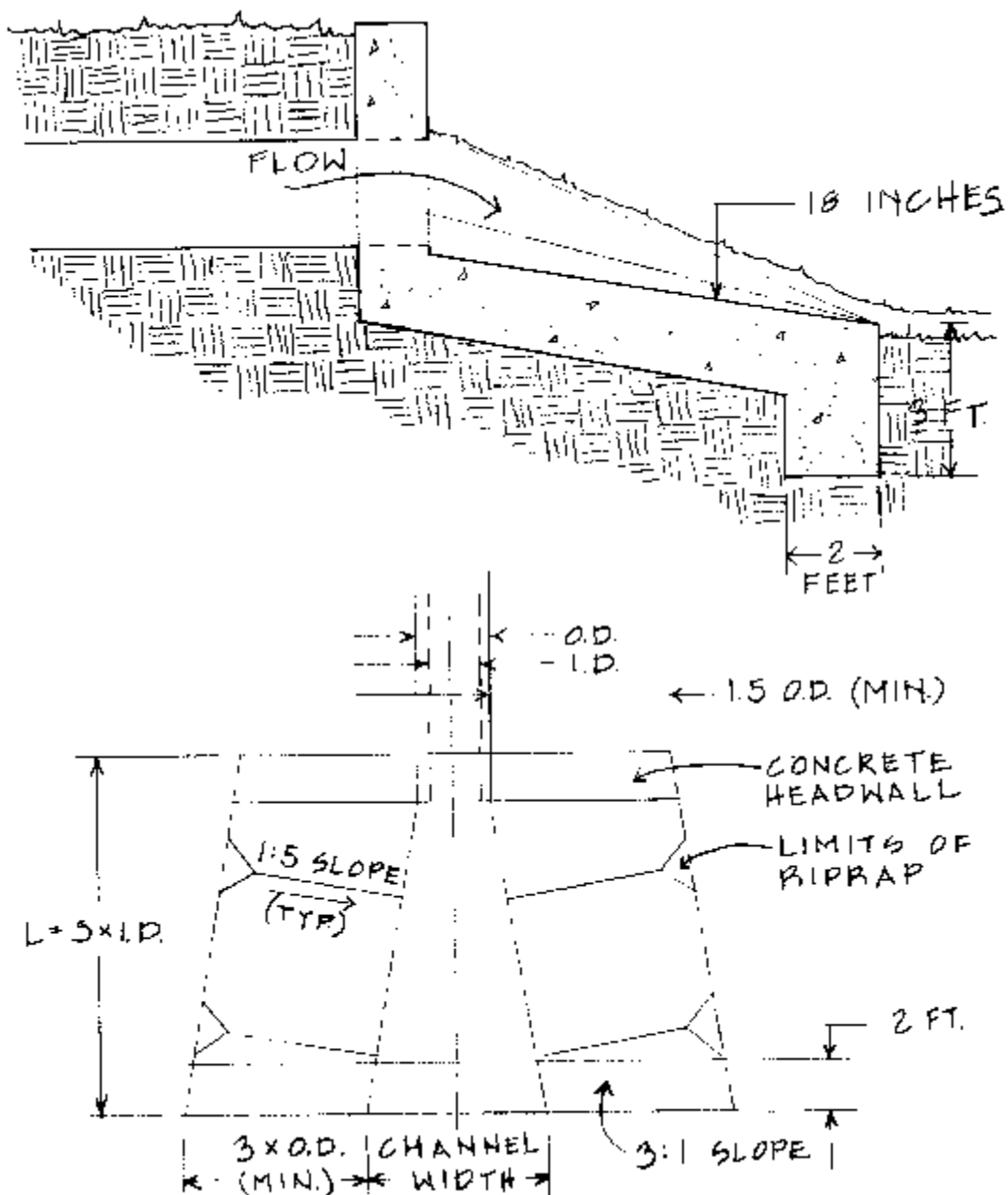



standard energy dissipater headwall or other suitable substitute should be used. The height of erosion protection should not be less than the top of the pipe. Toewalls should be provided at the down-stream end of all headwalls and flared end sections. Toewalls should typically extend a minimum of 18 inches below channel grade.

**Figure 6. Curb Opening Erosion Protection**

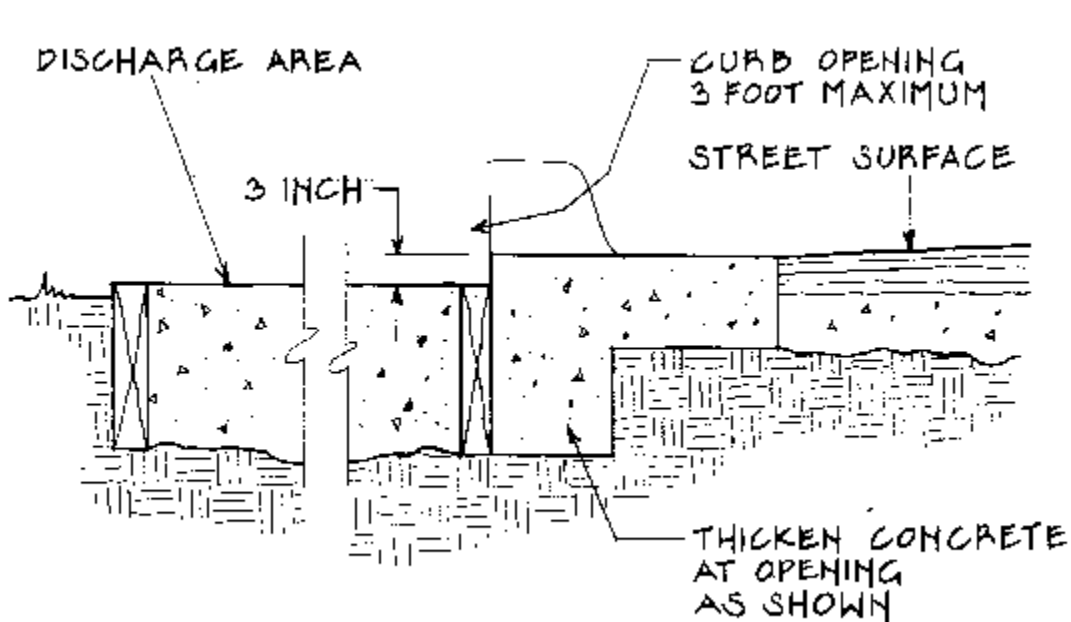

Where drainage flows from paved areas to grass areas through curb openings, erosion protection should be provided as shown in Figure 6. The riprap discharge area should be a minimum of 5 feet on a side and one-foot deep with a border of 2-inch by 12-inch CCA boards.

In grass channels, grades and velocities may be controlled by use of grade checks and drop structures. Grade checks should be placed in natural channels where average velocity for the peak flow rate from the minor storm exceeds five feet per second for post-development conditions.

Erosion protection should be provided at spillways and outlet structures for detention ponds. Erosion protection should extend to the point where flow has been stabilized and average velocity in the outlet channel does not exceed the erosive velocity of that channel.

### ***Seeding and Mulching***

As soon as practical, disturbed areas should be seeded and mulched to reduce the potential for further erosion. Seeding may be permanent if all work in the disturbed area is complete or temporary if the area is to be disturbed again at a later date. Proper seedbed preparation, selection of appropriate species, and use of quality seed are

important. Failure to carefully follow established guidelines and recommendations, below or provide by suppliers, can result in an inadequate or short-lived stand of vegetation that will not control erosion.

**Seedbed Preparation.** Good seedbed preparation is essential to successful plant establishment. Before preparing seedbeds, complete grading and install all necessary erosion control practices, such as dikes, waterways, and basins. Steep slopes should be minimized because they make seedbed preparation difficult and increase the erosion hazard. If soils become compacted during grading, loosen them to a depth of 6-8 inches using a ripper, harrow, or chisel plow. If recent tillage operations have resulted in a loose surface, additional roughening may not be required except to break up large clods. If rainfall causes the surface to become sealed or crusted, loosen it just prior to seeding by disking, raking, harrowing, or other suitable methods. Slopes steeper than 33 percent (3:1) grade should be grooved or furrowed on the contour before seeding. A good seedbed is well pulverized, loose, and uniform. Prior to permanent seeding, a minimum depth of two inches of loose topsoil should be spread on areas to be seeded. Where hydro-seeding methods are used, the surface may be left with a more irregular surface of large clods and stones.

Lime should be applied according to soil test recommendations. If the pH (acidity) of the soil is not known, an application of ground agricultural limestone at the rate of two tons/acre is usually sufficient. Lime should be applied uniformly and incorporated into the top 4-6 inches of soil. Soils with a pH of six or higher need not be limed.

Fertilizer should also be applied based on soil tests. When these are not possible, apply a 10-10-10 grade fertilizer at 700-1,000 lbs. per acre. Fertilizer should also be incorporated into the top 4-6 inches of soil.

**Seeding.** Disturbed areas that will not be brought to final grade for a period of more than 14 working days need to be temporarily stabilized by planting rapid-growing annual plants, which sprout and grow rapidly and survive for only one season, are suitable for establishing initial or temporary vegetative cover. Annual rye grass, wheat, or oats should be used for temporary seeding. Temporary seeding controls runoff and erosion until permanent vegetation or other erosion control measures can be established. Temporary seeding also preserves the integrity of earthen sediment control structures such as dikes, diversions, and the banks of dams and sediment basins. It can also reduce the amount of maintenance associated with these devices. For example, the frequency that sediment basins will have to be cleaned out will be reduced if watershed areas, outside the active construction zone, are stabilized. In addition, it provides residue for soil protection and seedbed preparation and reduces problems of mud and dust production from bare soil surfaces during construction. Applications of this practice include diversions, dams, temporary sediment basins, temporary road banks, topsoil stockpiles and completed areas not ready for permanent seeding.

Temporary seeding provides protection for no more than one year, during which time permanent stabilization should be initiated. Permanent seeding should be applied based on your supplier's recommendation or as follows.

SEED	BROADCAST RATES	DRILLED SODDED RATES
Tall Fescue	30 LB/acre	25 LB/acre solid
Kentucky Bluegrass	3 LB/acre	2 LB/acre solid
Red Fescue	10 LB/acre	7 LB/acre
Wheat or Rye	120 LB/acre	100 LB/acre
Annual Ryegrass	100 LB/acre	100 LB/acre

Evenly apply seed using a cyclone seeder (broadcast), drill, cultipacker seeder, or hydro-seeder. Broadcast seeding and hydro-seeding are appropriate for steep slopes where equipment cannot be driven. Distributing seed by hand is not recommended because of the difficulty in achieving a uniform distribution.

Small grains should be planted no more than one inch deep, and grasses and legumes no more than 1/2 inch. Broadcast seed must be covered by raking or chain dragging, and then lightly firmed with a roller or cultipacker. Hydro-seeded mixtures should include wood fiber (cellulose) mulch.

Seeded areas should be maintained for one year following permanent seeding to ensure a healthy lawn.

**Mulching.** The use of appropriate mulch will help ensure the vegetation is established under normal conditions and is essential to seeding success under harsh site conditions. Harsh site conditions include:

- a. Seeding in fall or winter cover (wood fiber mulches are not considered adequate for this use);
- b. Slopes steeper than 33 percent (3:1) grade;
- c. Excessively hot or dry weather;
- d. Adverse soils (shallow, rocky, or high in clay or sand; and
- e. Areas receiving concentrated flow.

Mulching is not necessary but recommended where slopes are less than five percent (20:1) grade. Where slopes are less than 25 percent (4:1) grade, cereal grain mulch can be applied at the rate of 100 pounds per 1,000 square feet (4,500 LB/acre). Where slopes are 25 percent (4:1) or greater grade, Type 3 mulch should be used. If the area to be mulched is subject to concentrated water flow, as in channels, anchor mulch with netting.

## Sediment Containment

Sediment must be contained whenever grading or removal of existing vegetation disturbs land.

### ***Existing Vegetation***

Existing vegetation can be an effective means to filter and contain sediment in areas where sheet flow occurs and the existing vegetative growth is of sufficient density and in sufficiently good condition to provide for filtration of sediment. An area of existing vegetation a minimum of twenty-five feet in width should be maintained between the area to be graded and a property line, water course, or mining feature. The existing ground slope should not exceed a twenty percent (5:1) grade. If existing vegetation does not prove to be effective, bale dikes or silt fences should be installed.

### ***Bale Dikes***

Hay and straw bale dikes should be used for temporary containment only when control will be required for three months or less. The area draining to the barriers should be 1/2 acre, or less, with no concentration of water in a channel above the barrier (sheet flow). The maximum slope length above the barrier should not exceed 100 feet and the grade

**Figure 7. Bale Dike Construction**

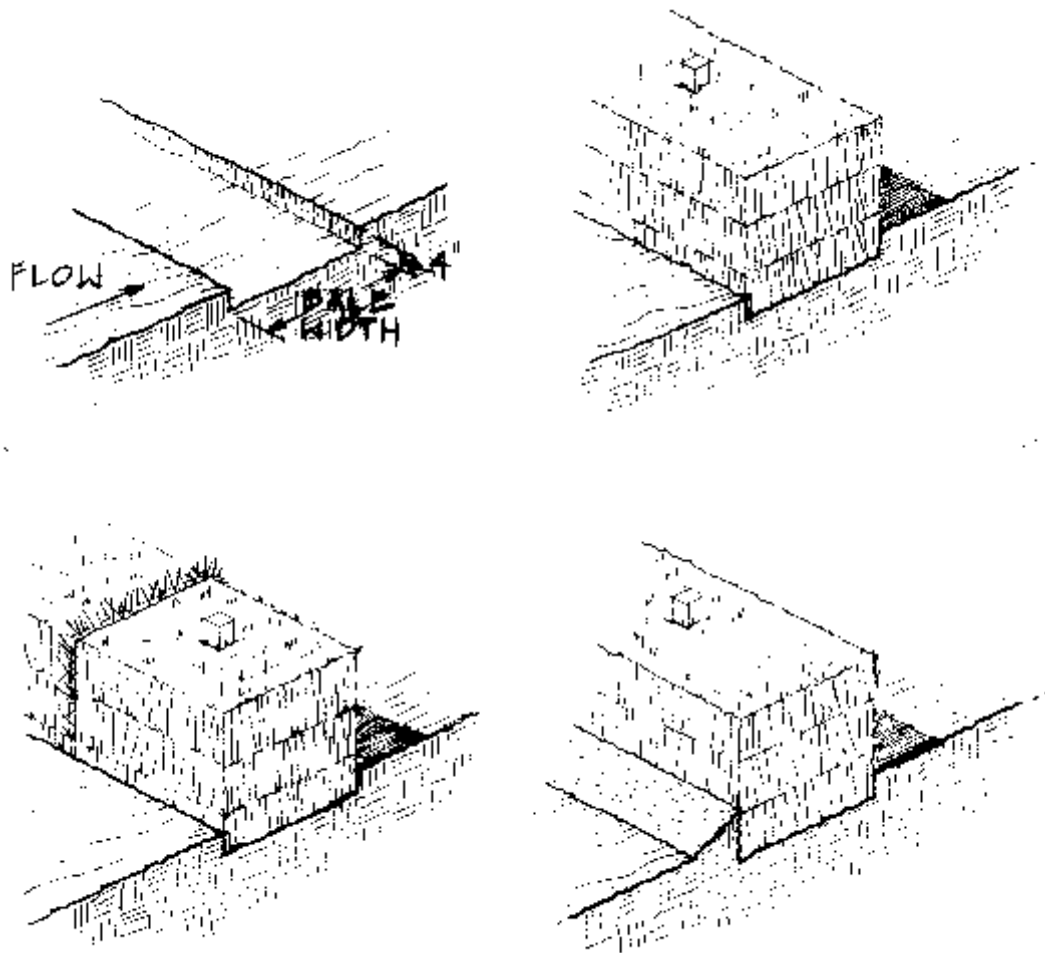

above the barrier should not exceed two percent (50:1). When placed across a small-swale, the maximum flow is one cubic foot per second.

Bale dikes should not be used on high sediment producing areas, above "high risk" areas, where water concentrates, or where there would be a possibility of a washout. Either cereal grain straw or hay can be used for bale dikes. Straw/hay bale dikes should be constructed as shown in Figures 7 & 8. The following guidelines apply for sheet flow applications.

- a. Bales should be placed in a single row, lengthwise on the contour, with ends of adjacent bales tightly abutting one another.
- b. All bales should be either wire-bound or string-tied. Straw bales should be installed so that bindings are oriented around the sides rather than along the tops and bottoms of the bales.

**Figure 8. Bale Dike Construction**

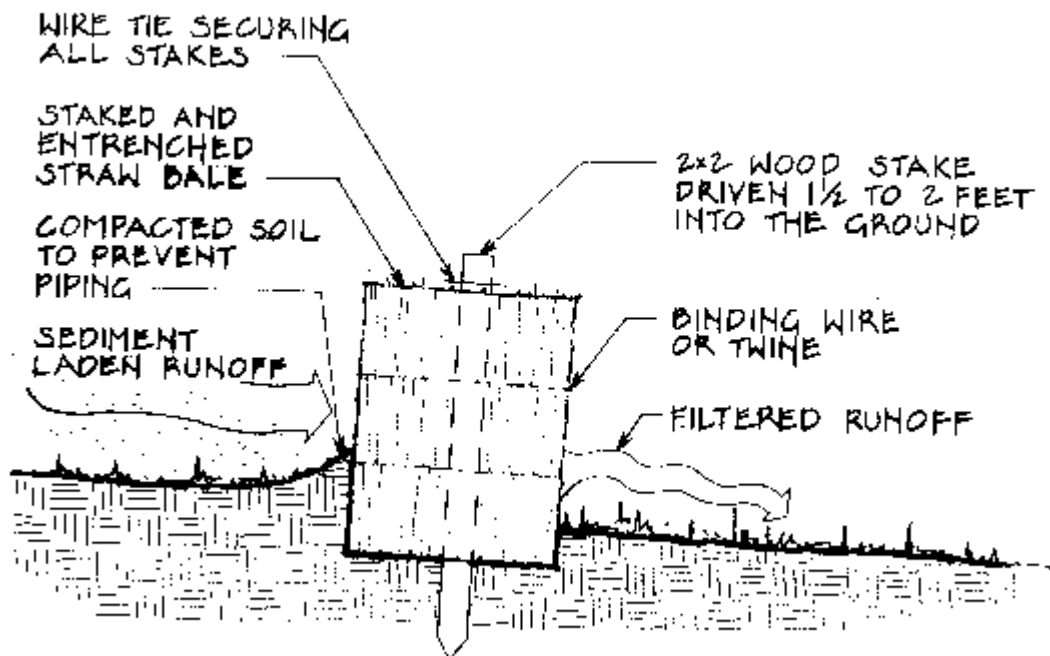

- c. The barrier should be entrenched and back-filled. The trench should be excavated the width of a bale and the length of the proposed barrier to a minimum depth of four inches. After the bales are staked and chinked, the excavated soil should be back-filled against the barrier. Back-fill soil should

conform to the ground level on the downhill side and should be built up to four inches against the uphill side of the barrier.

- d. At least two stakes or rebars driven through the bale should securely anchor each bale. The first stake in each bale should be driven toward the previously laid bale to force the bales together. Stakes or rebars should be driven deep enough into the ground to securely anchor the bales.
- e. The gaps between bales should be chinked (filled by wedging) with straw to prevent water from escaping between the bales. Loose straw should be scattered over the area immediately uphill from a straw bale barrier to increase the barrier efficiency.
- f. Bale dikes should be removed when they have served their usefulness, but not before the upslope areas have been permanently stabilized.

If the dike will be constructed in a shallow swale, the above construction needs to be modified. Bales should be placed in a single row, lengthwise, oriented perpendicular to the contour, with ends of adjacent bales tightly abutting one another. The barrier should be extended to such a length that the bottoms of the end bales are higher in elevation than the top of the lowest middle bale to assure that sediment-laden runoff will flow either through or over the dike but not around it (Figure 9).

**Figure 9. Bale Dike Construction**



(a) INCORRECT AND (b) CORRECT ABUTMENT OF STRAW BALES IN A TRENCH

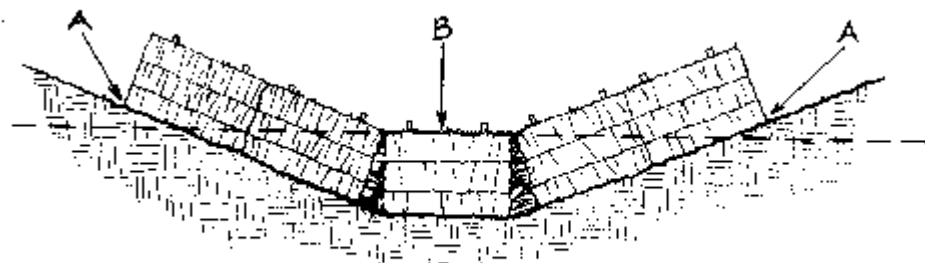

POINTS A SHOULD BE HIGHER THAN B

Bale dikes should be inspected immediately after each rainfall and at least daily during prolonged rainfall. Close attention should be paid to the repair of damaged bales, end runs and undercutting beneath bales. Necessary repairs to barriers or replacement of bales should be done promptly. Sediment deposits should be removed after each rainfall and in no event should accumulated silt be allowed to exceed a depth of one-half the height of the barrier. Remove the barrier and unstable deposits and bring the area to grade and stabilize it after the contributing drainage area has been properly stabilized.

### ***Silt Fences***

Silt fences may be used in lieu of hay or straw bales and are preferred because they last longer if properly installed. Silt fences are temporary sediment barriers consisting of filter fabric buried at the bottom, stretched, and supported by posts. They are intended to intercept and detain small amounts of sediment from disturbed areas during construction operations by reducing the velocity of sheet flows and low-to-moderate level channel flows. They are applicable in ditch lines, around drop inlets, and at temporary locations where continuous construction changes the earth contour. Filter barriers should have an expected usable life of six months.

The area draining to the silt fence should not exceed one acre, or 1/4 acre per 100 feet of fence, with no concentration of water in a channel above the barrier (sheet flow). The maximum slope length above the barrier should not exceed 100 feet and the grade above the barrier should not exceed twenty percent (5:1). When placed across a small-swale, the maximum flow should be one cubic foot per second. The sediment fence should be constructed to store runoff without damaging the fence or the submerged area behind the fence.

Silt fences should be constructed as shown in Figure 10. Use a synthetic filter fabric which:

- a. Contains ultraviolet ray inhibitors and stabilizers to provide a minimum of six months of expected usable construction life at a temperature range of 0 to 120 degrees F;
- b. Has an equivalent opening size of a U.S. standard sieve of 70; and
- c. The tensile strength at 20 percent elongation is 30 pounds/lineal inches.

Where flows do not exceeding one cubic foot per second, silt fences can be constructed as follows.

- a. The height of a filter barrier should be a minimum of 15 inches and a maximum of 18 inches.
- b. Posts should be either 4-inch diameter wood or 1.33 pounds per linear foot steel with a minimum length of five feet. Steel posts should have projections for

fastening wire to them. The posts should be spaced a maximum of three feet apart at the barrier location and driven securely into the ground (minimum of eight inches).

- c. A trench should be excavated approximately four inches wide and four inches deep along the line of stakes and upslope from the barrier.
- d. The filter material should be wired to metal posts or stapled to wooden posts using at least 1/2-inch long staples. Filter material should not be stapled to existing trees. The filter fabric should be installed in a continuous sheet the length of the barrier to avoid the use of joints. When joints are necessary, filter cloth should be spliced together only at a support post, with a minimum 6-inch overlap, and securely sealed. Eight inches of the fabric should be extended into the trench.
- e. If wire fence reinforcement is used, it should be 36 inches high, 14-gauge, and a maximum mesh spacing of 6 inches. The fence should be fastened securely to the upslope side of the posts using heavy duty wire staples at least one inch long, tie wires or hog rings. The wire should extend into the trench a minimum of two inches.
- f. The trench should be back-filled and the soil compacted over the filter material.

If a silt fence is to be constructed across a ditch line or swale, the barrier should be of sufficient length to eliminate end flow, and the configuration should resemble an arc or horseshoe with the ends oriented upslope.

Where only sheet flows are expected, the silt fences can be constructed as described above except, the height of a silt fence can be increased to a maximum of 36 inches (higher fences may impound volumes of water sufficient to cause failure of the structure). The posts should be spaced a maximum of ten feet apart at the barrier location and driven securely into the ground (minimum of 18 inches) when used with the wire support fence, otherwise, post spacing should not exceed three feet.

A riprap splash pad or other outlet protection device should be provided for any point where flow may overtop the sediment fence, such as natural depressions or swales. Ensure that the maximum height of the fence at a protected, reinforced outlet does not exceed one foot and that support post spacing does not exceed three feet.

All silt fences should be inspected at least once a week and after each rainfall. Make any required repairs immediately. Should the fabric of a sediment fence collapse, tear, decompose, or become ineffective, replace it promptly. Remove sediment deposits as necessary after each storm to provide adequate storage volume for the next rain and to reduce pressure on the fence. Care needs to be taken to avoid undermining the fence when removing sediment.



All fencing materials and unstable sediment deposits should be removed and the area brought up to grade and stabilized after the contributing drainage area has been properly stabilized.

**Figure 10. Silt Fence Construction**

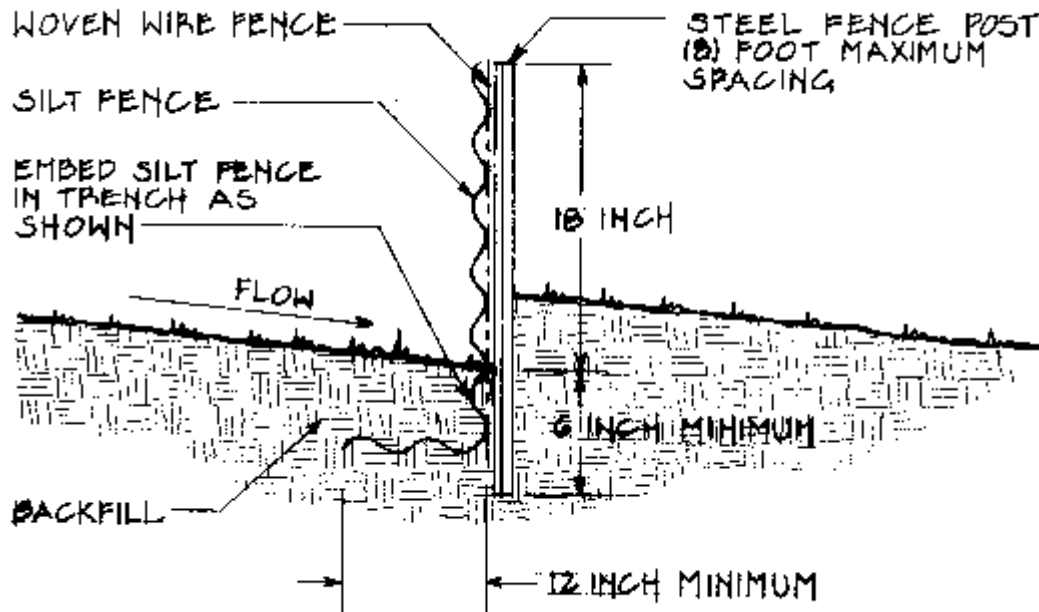

### ***Temporary Sediment Basins***

Temporary sediment basins should be provided for areas where concentrated flow from areas greater than one acre occurs. They are small temporary ponding areas formed by excavation, an embankment or a combination across a drainageway. Temporary sediment basins are designed to detain sediment-laden runoff from small disturbed areas for a period of time to allow sediment to settle reducing sediment deposits and runoff turbidity downstream.

Sediment trapping is achieved primarily by settling within a pool. Sediment-trapping efficiency is a function of surface area and geometry of the basin and inflow rate. Therefore, maximize the surface area in the design. Installations that provide pools with large length to width ratios reduce short circuiting and allow more of the pool surface area for settling.

Locations for sediment basins need to be selected during site evaluation. Note natural drainage divides and select basin sites so that runoff from potential sediment-producing

areas can be easily diverted into the basins. The drainage areas for each basin should not exceed five acres. Basins should be readily accessible for periodic sediment removal and other necessary maintenance. Plan locations for sediment disposal as part of basin site selection. In preparing plans for sediment basins, it is important to consider provisions to protect the embankment from failure from storm runoff that exceeds the design capacity. Consider non-erosive emergency bypass areas, particularly if there could be severe consequences from failure. If a bypass is not possible and failure would have severe consequences, consider alternative sites. Because well-planned sediment basins are key measures to preventing offsite sedimentation, they should be installed in the first stages of project development.

Temporary containment berms should be designed to contain a volume of 1,800 cubic feet per acre of drainage area (Figure 11). Measure volume below the crest elevation of the outlet. The volume of a natural sediment trap may be satisfactorily approximated by the equation:

$$\text{volume (ft}^3\text{)} = 0.4 \times \text{surface area (ft}^2\text{)} \times \text{max. pool depth (ft)}$$

Each end of the berm should turn upslope and extend until the ground surface rises to the top of the berm elevation. Berms for temporary sediment traps should not exceed five feet in height measured at the center line from the original ground surface to the top of the berm. Additional freeboard may be added to the berm height to allow flow through a designated bypass location. Construct berms with a minimum top width of five feet and side slopes of 2:1 or flatter. Where sediment pools are formed or enlarged by excavation, also keep side slopes at 2:1 or flatter for safety. Clear, grub, and strip the area under the embankment of all vegetation and root mat. Remove all surface soil containing high amounts of organic matter and stockpile or dispose of it properly. Ensure that fill material for the embankment is free of roots, woody vegetation, organic matter, and other objectionable material. Place the fill in lifts not to exceed nine inches and machine compact it. Over fill the embankment six inches to allow for settlement.

Temporary containment berms should have a perforated PVC pipe outlet (Figure 12) or equivalent. The perforated pipe should have holes sized and spaced to provide adequate detention time for settling. The height of the pipe (H) should be level with the top of the berm. The solid PVC pipe should be bedded in clean gravel.

An alternative is to construct an outlet using a stone section of embankment located at the low point in the basin (Figure 13). The stone section serves two purposes:

- a. The top section serves as a non-erosive spillway outlet for flood flows; and
- b. The bottom section provides a means of de-watering the basin between runoff events.

Figure 11. Temporary Containment Berm

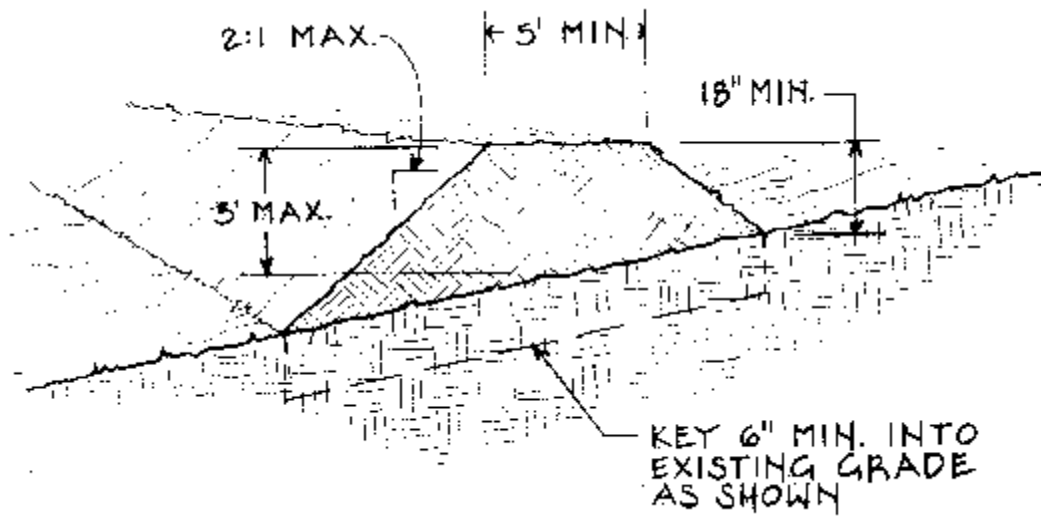
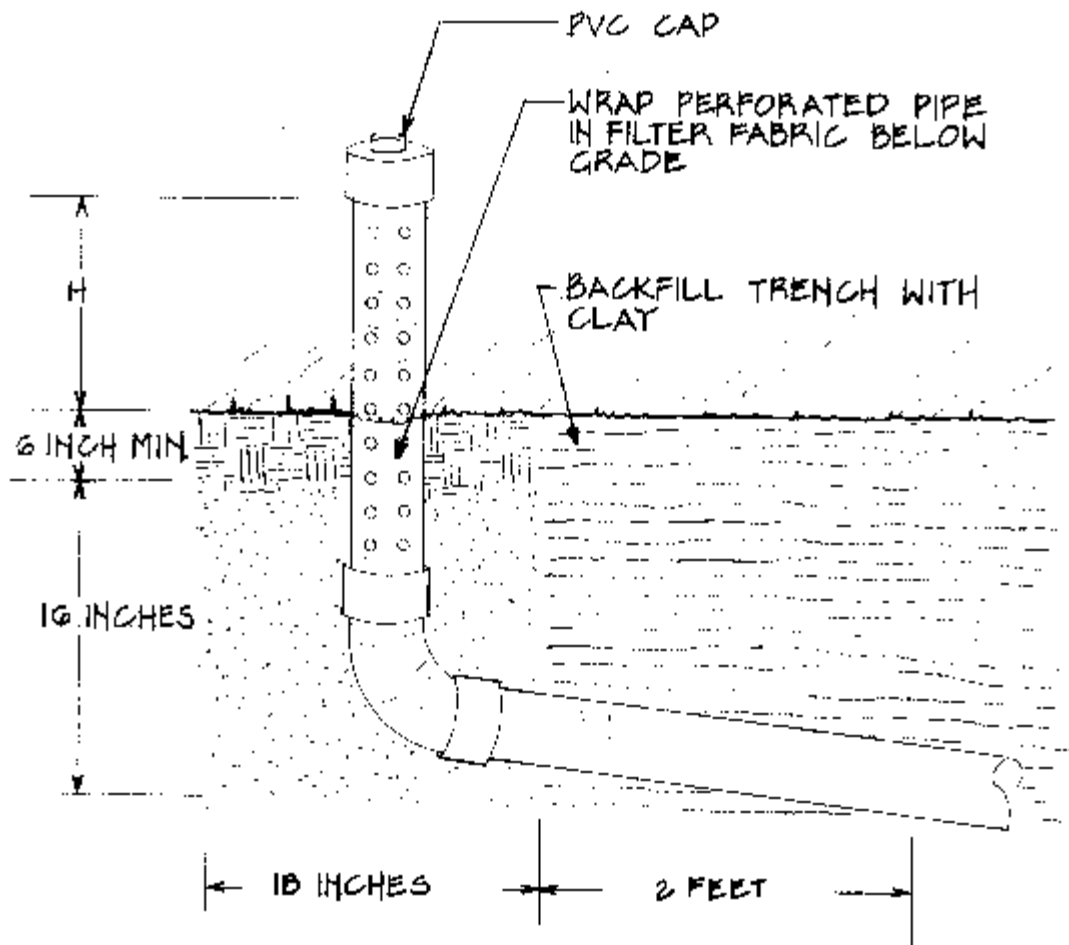

Figure 12. PVC Outlet Pipe



The outlet is constructed using material such as riprap. A one-foot thick layer of 1/2 to 3/4-inch aggregate should be placed on the inside face to reduce drainage flow rate. Keep the side slopes of the spillway section at 2:1 or flatter. To protect the embankment, the sides of the spillway need to be at least 21 inches thick. Keep the crest of the spillway outlet a minimum of 1.5 feet below the settled top of the embankment. Filter cloth should be placed on the foundation below the riprap to prevent piping. An alternative is to excavate a keyway trench across the riprap foundation and up the sides to the height of the dam. The spillway weir needs to be at least four feet long and sized to pass the peak discharge of the 10-year storm. There should be a maximum flow depth of one foot, a minimum freeboard of 0.5 foot, and maximum side slopes of 2:1.

The outlet section is constructed in the embankment. The connection between the riprap and the soil from piping should be protected by using filter fabric or a keyway cutoff trench between the riprap structure and the soil.

- a. Place the filter fabric between the riprap and soil. Extend the fabric across the spillway foundation and sides to the top of the dam; or
- b. Excavate a keyway trench along the centerline of the spillway foundation extending up the sides to the height of the dam. The trench should be at least two-foot deep and two-foot wide with 1:1 side slopes.

The pond area below the elevation of the crest of the spillway should to be cleared to facilitate removal of sediment. Ensure that the stone (drainage) section of the embankment has a minimum bottom width of three feet and maximum side slopes of 1:1 that extend to the bottom of the spillway section. Construct the minimum finished stone spillway bottom width with 2:1 side slopes extending to the top of the over filled embankment. The thickness of the sides of the spillway outlet structure should be a minimum of 21 inches. The weir must be level and constructed to grade to assure design capacity. Ensure that the stone spillway outlet section extends downstream past the toe of the embankment until stable conditions are reached and outlet velocity is acceptable for the receiving stream. The edges of the stone outlet section should be flush with the surrounding ground and the center shaped to confine the outflow stream. Direct emergency bypass to natural, stable areas. Locate bypass outlets so that flow will not damage the embankment. Stabilize the embankment and all disturbed areas above the sediment pool and downstream from the basin immediately after construction.

Temporary sediment basins should be inspected after each period of significant rainfall. When the sediment has accumulated to more than 6 inches in depth, remove sediment and restore the trap to its original dimensions. The contaminated part of the gravel facing needs to be replaced. Also check the structure for damage from erosion or piping and the depth of the spillway to ensure it is a minimum of 1.5 feet below the low point of the embankment. Immediately fill any settlement of the embankment to slightly above design grade. Any riprap displaced from the spillway must be replaced immediately. After all sediment-producing areas have been permanently stabilized, remove the structure and all unstable sediment. Smooth the area to blend with the adjoining areas and stabilize properly.

Figure 13. Stone Outlet

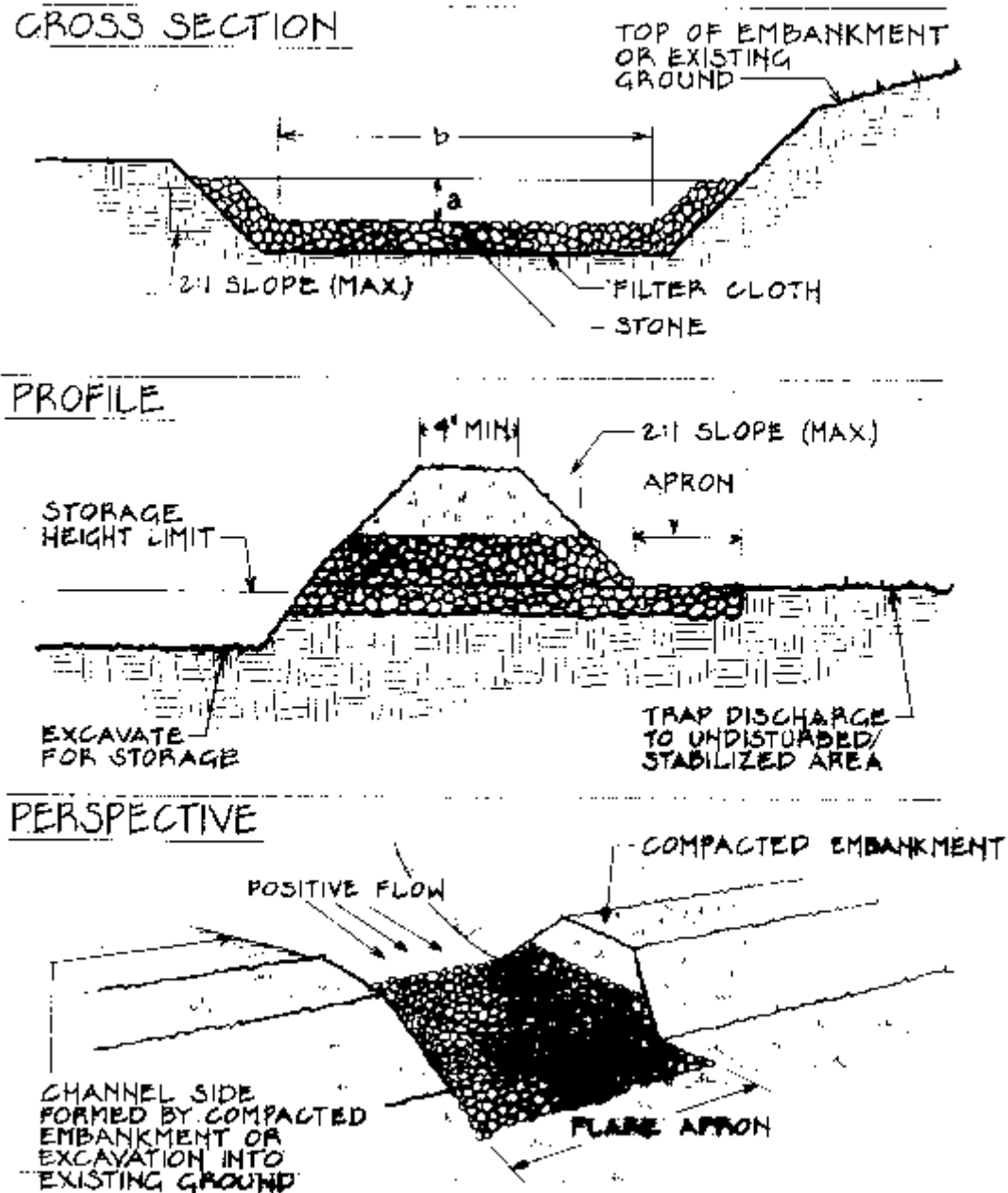

**Storm Drain Inlet Protection**

Storm sewers that are made operational before their drainage area is stabilized can convey large amounts of sediment to downstream drainageways. In case of extreme sediment loading, the storm sewer itself may clog and lose a major portion of its capacity. To avoid these problems, it is necessary to prevent sediment from entering the system at the inlets. This practice allows use of permanent storm water conveyance at

an early stage of site development. Storm drain drop inlets or curb inlets need to be protected by sediment filters or temporary containment areas that trap sediment at the approach to the storm drainage systems. This method of inlet protection applies to both drop inlets and curb inlets where heavy flows are expected and an overflow capacity is necessary to prevent excessive ponding around the structure

There are several types of inlet filters and traps that have different applications dependent upon site conditions and type of inlet. Other innovative techniques for accomplishing the same purpose may be considered.

The following examples of inlet protection devices are for drainage areas of less than one acre. They are intended to keep sediment out of the storm drain, and they do not have a large sediment storage area. Excavating an area around the inlet for deposition of sediment will improve the capture rate, reduce frequency of maintenance, and allow the device to serve an area larger than one acre. The inlet protection device should be constructed in such a manner that will facilitate clean-out and disposal of trapped sediment and minimize interference with construction activities. The devices should also be constructed in such a manner that any resultant ponding or stormwater will not cause excessive inconvenience or damage to adjacent areas or structures. Shallow temporary flooding after rainfall should be expected.

None of these methods are applicable in public streets or rights-of-way. Sediment must be trapped before stormwater enters a public right-of-way.

#### ***Bale and Filter Fabric Filters***

These methods of inlet protection are applicable where the inlet drains slopes with a five percent (20.1) grade or less and flows do not exceed 0.5 cubic feet per second. These methods should not be used for inlets receiving concentrated flows. Design is similar to other applications (Figures 14 & 15).

- a. Bales should be either wire-bound or string-tied with the bindings oriented around the sides rather than over and under the bales.
- b. Bales should be placed lengthwise in a single row surrounding the inlet, with the ends of adjacent bales pressed together.
- c. The barrier should be entrenched and back-filled. A trench should be excavated around the inlet the width of a bale to a minimum depth of four inches. After the bales are staked, the excavated soil should be back-filled and compacted against the filter barrier.
- d. Each bale should be securely anchored and held in place by at least two stakes or rebars driven through the bale.
- e. Loose straw should be wedged between bales to prevent water from entering between bales.

Figure 14. Bale Inlet Protection

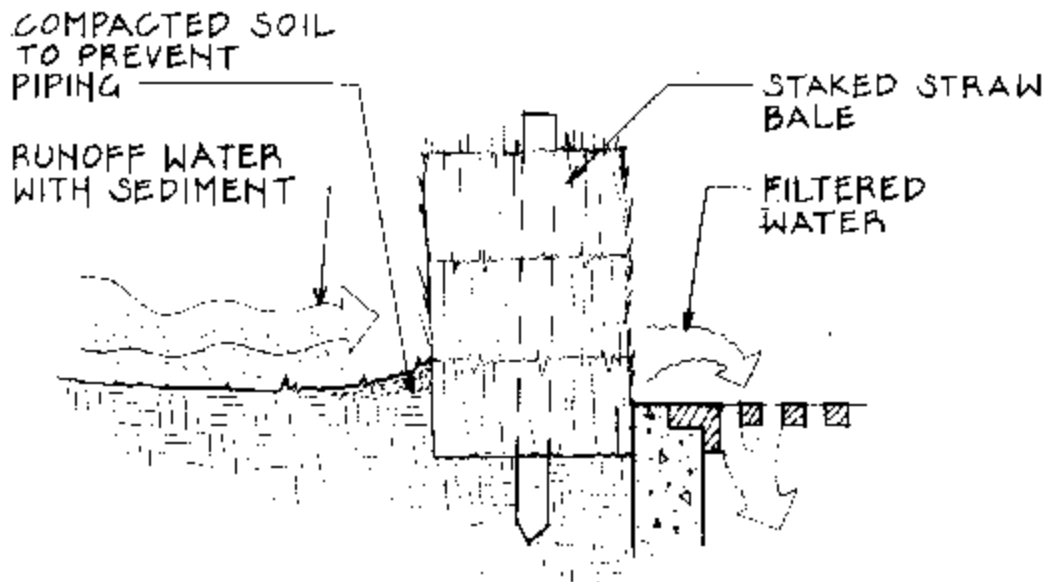
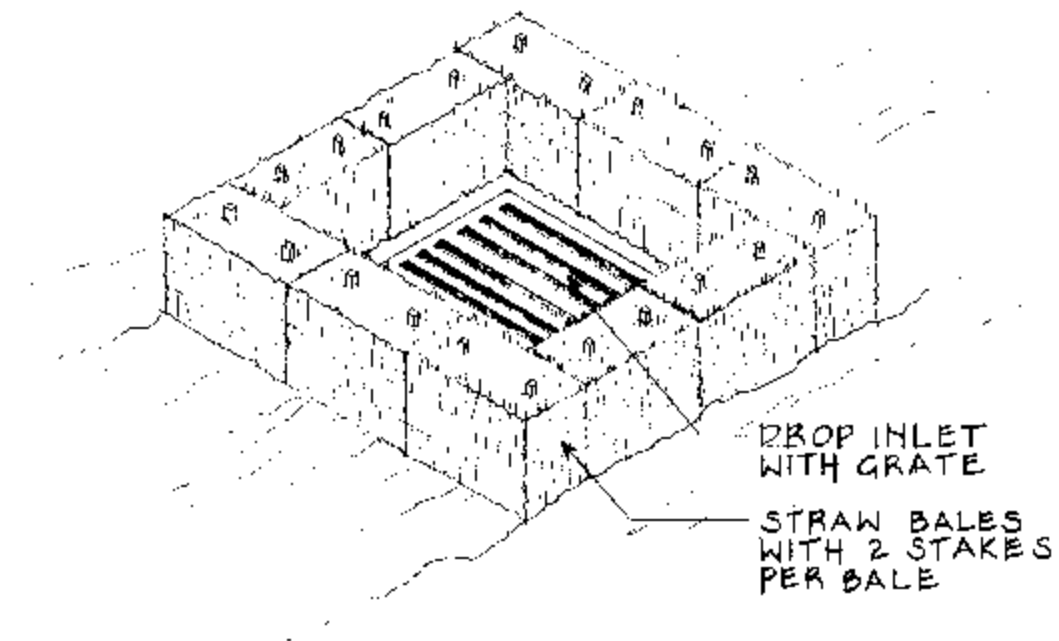

**Figure 15. Silt Fence Inlet Protection**

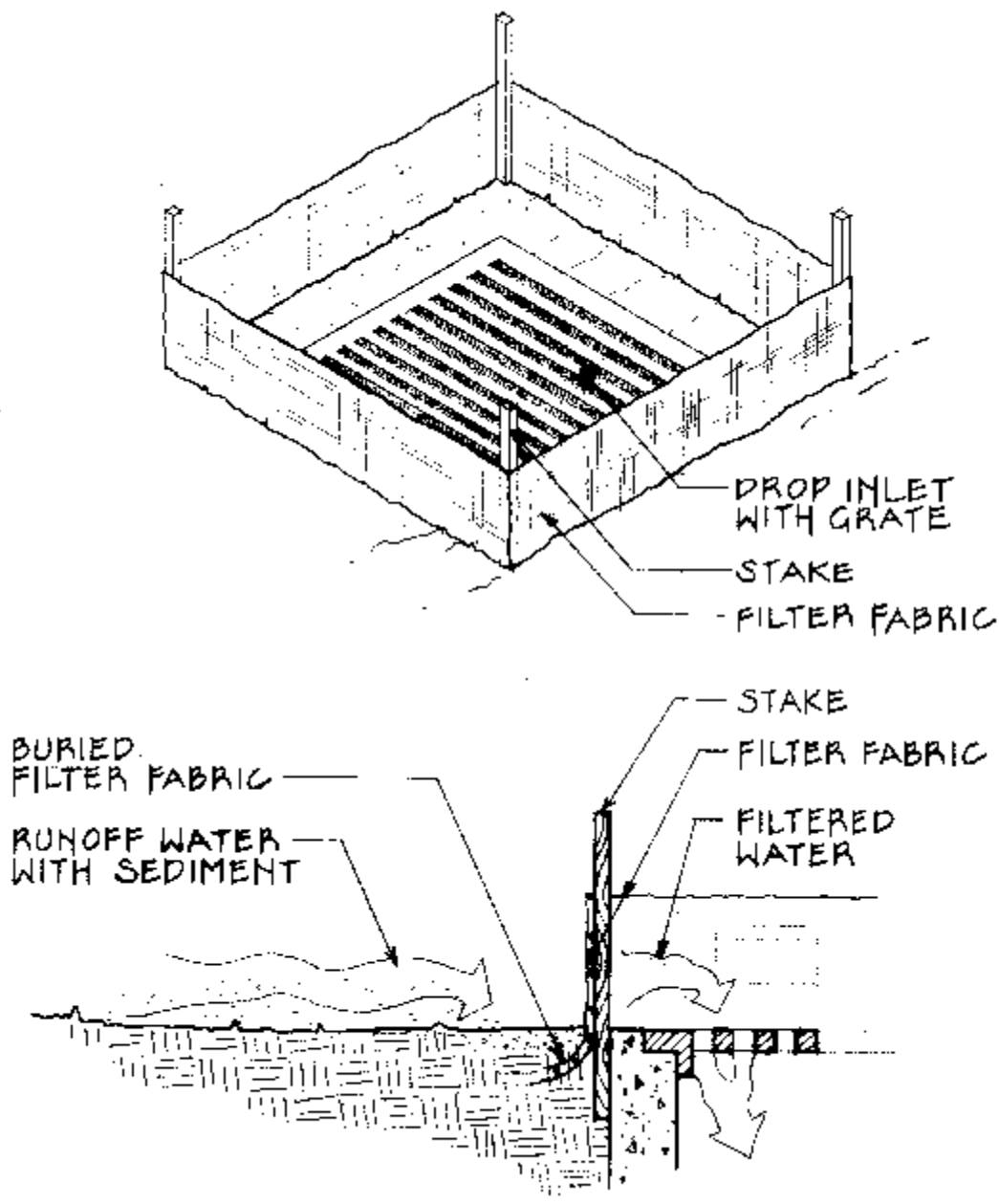

***Gravel And Wire Mesh Sediment Filters***

This method is effective where very concentrated flows are expected but not where ponding around the structure might cause excessive inconvenience or damage to adjacent structures or unprotected areas.



- a. Wire mesh should be laid over the drop inlet so that the wire extends a minimum of one foot beyond each side of the inlet structure. Hardware cloth or comparable wire mesh with 1/2-inch openings should be used. If more than one strip of mesh is necessary, the strips should be overlapped.
- b. One to two-inch clean aggregate should be placed over the wire mesh as indicated on Figure 16. The depth of stone should be at least 12 inches over the entire inlet opening. The stone should extend beyond the inlet opening at least 18 inches on all sides.
- c. If the stone filter becomes clogged with sediment so that it no longer adequately performs its function, the stones must be pulled away from the inlet, cleaned and replaced.

This filtering device has no overflow mechanism; therefore, ponding is likely, especially if sediment is not removed regularly. This type of device must never be used where overflow may endanger an exposed fill slope. Consideration should also be given to the possible effects of ponding on traffic movement, nearby structures, working areas, adjacent property, etc.

**Figure 16. Gravel and Wire Mesh Sediment Filter**

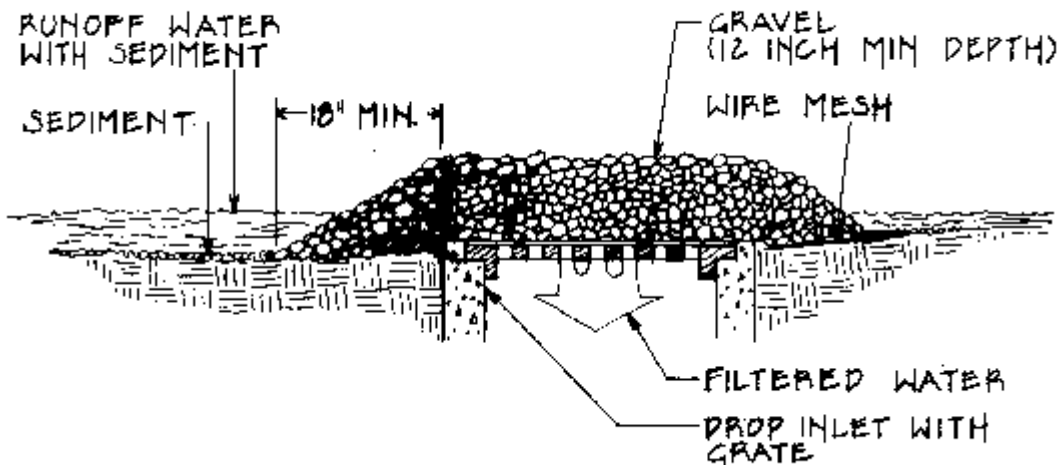

***Excavated Drop Inlet Sediment Trap***

This method is applicable where heavy flows are expected and where overflow capacity and ease of maintenance are desired (Figure 17).

- a. The excavated trap should be sized to provide a minimum storage capacity calculated at the rate of 67 cubic yards for one acre of drainage area. A trap should be no less than one foot nor more than two feet deep measured from the top of the inlet structure. Side slopes should not be steeper than a 33 percent (3:1) grade.
- b. The slope of the basin may vary to fit the drainage area and terrain. Observations must be made to check trap efficiency and modifications should be made as necessary to insure satisfactory trapping of sediment. Where an inlet is located to receive concentrated flows it is recommended that the basin have a rectangular shape in 2:1 ratio, with the length oriented in the direction of the flow.

**Figure 17. Excavated Drop Inlet Sediment Trap**

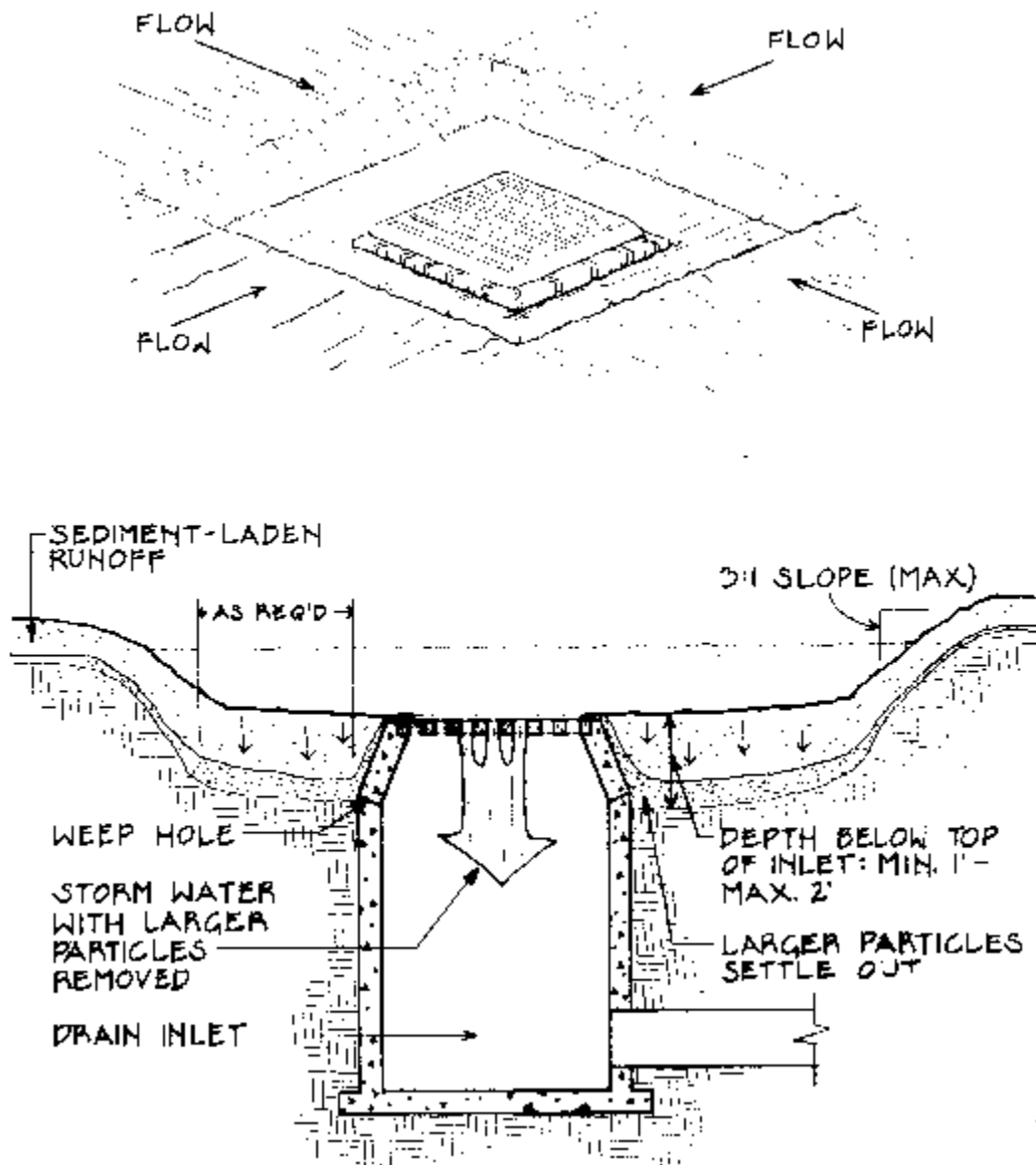

- c. Sediment should be removed and the trap restored to its original dimensions when the sediment has accumulated to 6 inches. Removed sediment should be deposited in a suitable area and in a manner such that it will not erode.

### **Gravel Curb Inlet Sediment Filter**

This method can be used where ponding in front of the structure will not cause inconvenience or damage to adjacent structures and unprotected areas (Figure 18).

- a. Hardware cloth or comparable wire mesh with 1/2-inch openings should be placed over the curb inlet opening so that at least 12 inches of wire extends across the inlet cover and at least 12 inches of wire extends across the concrete gutter from the inlet opening.

**Figure 18. Gravel Curb Inlet Sediment Filter**

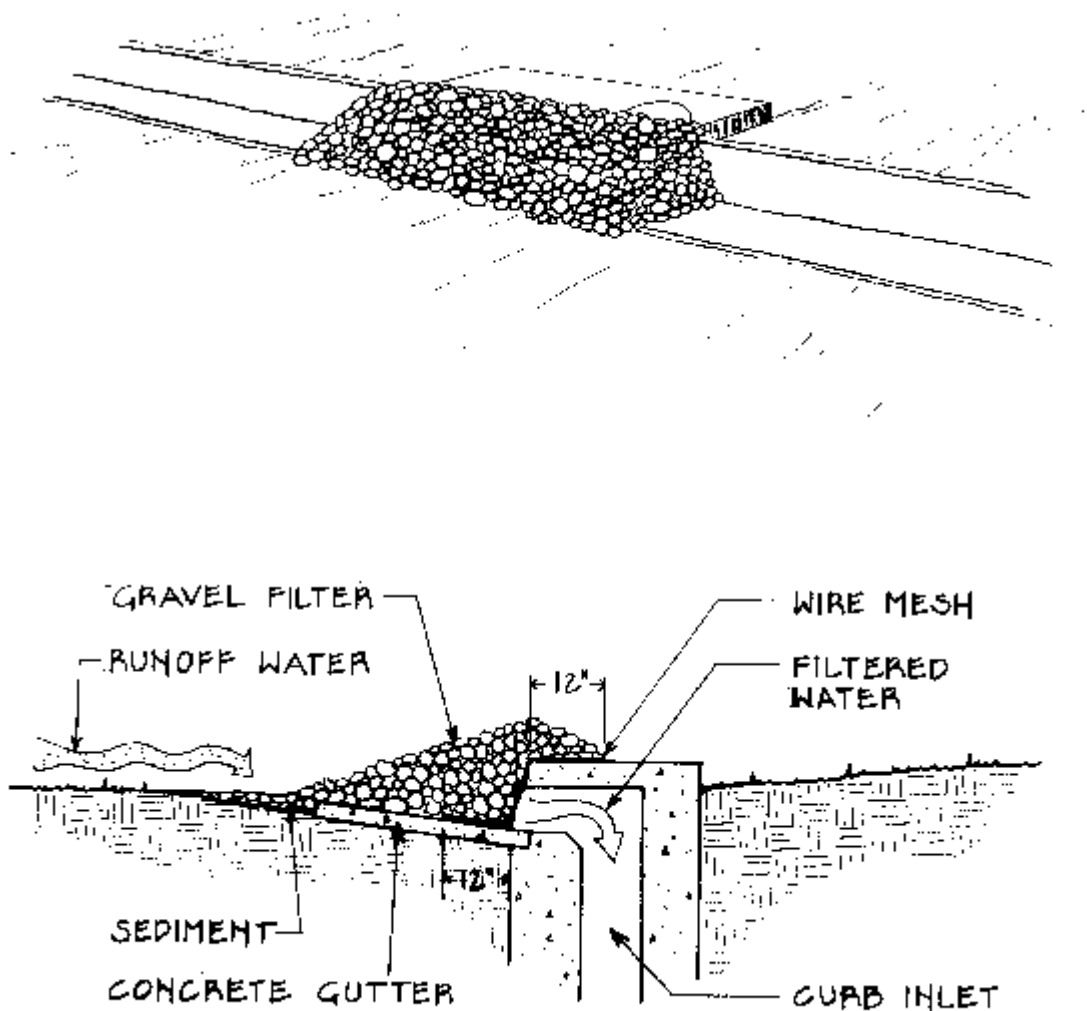

- b. Stone should be piled against the wire so as to anchor it against the gutter and inlet cover and to cover the inlet opening completely. One to two-inch clean aggregate should be used.
- c. If the stone filter becomes clogged with sediment so that it no longer adequately performs its function, the stone must be pulled away from the block, clean, and replaced.

**Block and Gravel Curb Inlet Sediment Filter**

This method can be used where an overflow capability is necessary to prevent excessive ponding in front of the structure (Figure 19).

**Figure 19. Block and Gravel Curb Inlet Sediment Filter**

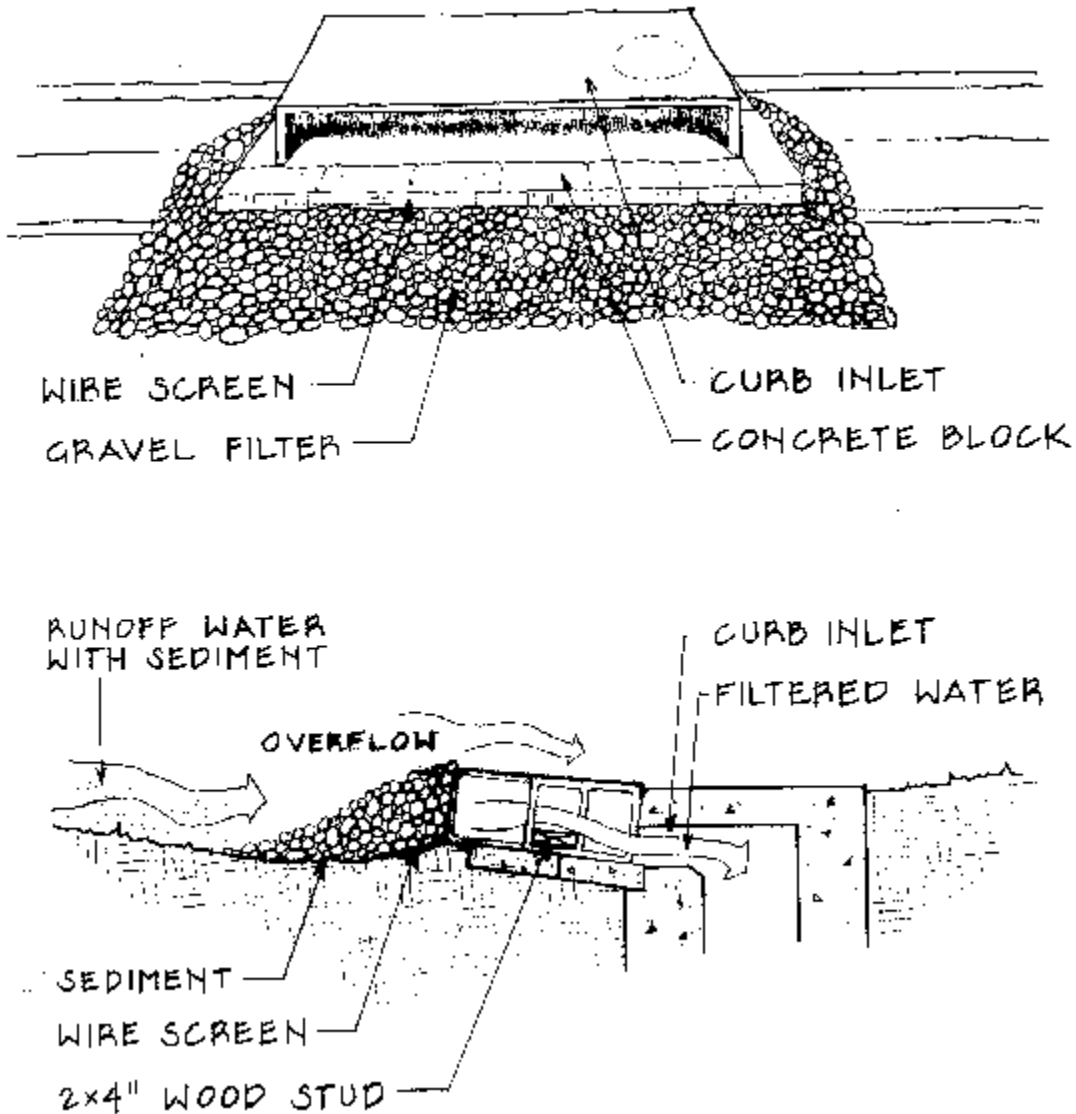

- a. Two concrete blocks should be placed on their sides abutting the curb at either side of the inlet opening.
- b. A two-inch by four-inch stud should be cut and placed through the outer holes of each spacer block to help keep the front blocks in place.
- c. Concrete blocks should be placed on their sides across the front of the inlet and abutting the spacer blocks.
- d. Wire mesh should be placed over the outside vertical face (webbing) of the concrete blocks to prevent stone from being washed through the holes in the blocks. Chicken wire or hardware cloth with 1/2-inch openings should be used.
- e. One to two-inch clean aggregate should be piled against the wire to the top of the barrier as shown in Plat 9.
- f. If the stone filter becomes clogged with sediment so that it no longer adequately performs its function, the stone must be pulled away from the block, cleaned, and replaced.

All sediment traps should be inspected after each rain and repairs made as needed. Sediment should be removed and the trap restored to its original dimensions when the sediment has accumulated to 6 inches. Removed sediment should be deposited in a suitable area and in such a manner that it will not erode. Structures should be removed, and the area stabilized when the remaining drainage area has been properly stabilized.

## **SEDIMENT ON PUBLIC STREETS**

City of Joplin regulations require that mud, dirt or other foreign matter not be deposited on city streets. Areas graded for construction vehicle transport and parking purposes are especially susceptible to erosion. The exposed soil surface is continually disturbed, leaving no opportunity for vegetative stabilization. Such areas also tend to collect and transport runoff waters along their surfaces. During wet weather, they often become muddy quagmires, which generate significant quantities of sediment that may pollute nearby streams or be transported offsite on the wheels of construction vehicles. Dirt roads can become so unstable during wet weather that they are virtually unusable. Immediate stabilization of such areas with stone may cost money at the outset, but it may actually save money in the long run by increasing the usefulness of the road during wet weather. Permanent roads and parking areas should be paved as soon as possible after grading. As an alternative, the early application of stone may solve potential erosion and stability problems and eliminate later re-grading costs. In certain cases, the stone will also remain in place for use as part of the base course of the road.

Temporary construction entrances should be constructed of two- to three-inch clean crushed limestone. The entrances should be a minimum of twelve feet wide and fifty feet long. Entrances to residential sites may be a minimum of 10 feet wide and 30 feet long. Minimum thickness of the crushed limestone surface shall be six inches.

Additional lifts of crushed limestone should be added if the surface of the initial drive deteriorates or becomes too muddy to be effective. In locations where an existing drive or street extends at least fifty feet into the site, the existing drive may serve as the construction entrance, and construction of a new gravel entrance is not necessary unless warranted by job conditions. Vehicle wheels should be cleaned to remove mud prior to entrance on to public rights-of-way. When washing is required, it should be done on an area, stabilized with crushed stone, which drains into a sediment trap. Streets adjacent to the site are required by ordinance to be completely cleaned of sediment and debris daily.